

- 3124-322-0975 - CEE - 3x32A / IP44 MAKİNE PRİZİ (DÜZ)(SABİT FLANŞ)(75x75)
CEE - 3x32A / PANEL MOUNT SOCKET OUTLET (STR.) (75x75)(IP44)

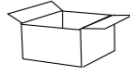

Ambalaj Mik.
Pack Unit

10



Ağırlık
Weight

170

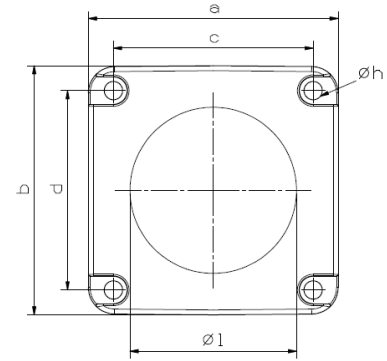
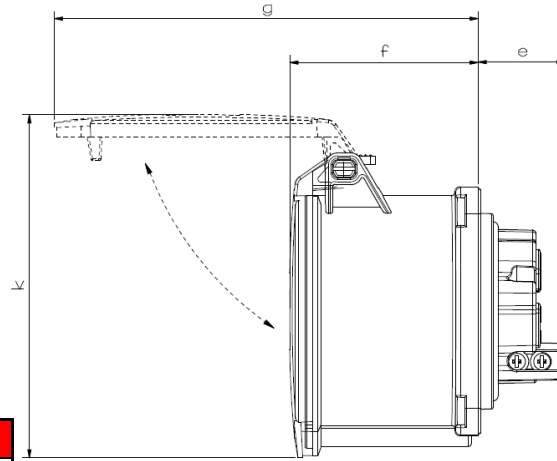

Ölçüler / Dimension

a	75	f	58
b	75	g	122
c	60	øh	5.5
d	60	øl	56
e	27	k	98
Kablo Çapı / Cond. Dia.(mm ²) (min.)			2.5
Kablı Çapı / Cond. Dia.(mm ²) (mix.)			6.0